

# More Than Play: Children learn important skills through Visual-Spatial Work!

Dr. Dana L. Miller, Researcher – Visual-Spatial project

The visual-spatial project, focusing on children's work in the block area, began in the spring of 1998. The goal was to understand how children develop visual-spatial skills, and how teachers can better support that development. Our primary research method was close observation of children working in the block area. First Plymouth teachers were already skilled at observing children's behavior but architect Kit Hatch trained them in an architectural technique called visual note-taking. She taught teachers to use a visual medium to depict children's visual-spatial work. In drawing the structures children were building, teachers began to observe children's work more closely, and notice even the most subtle nuances. In May 1998, four months into the project, one teacher wrote in her journal: "I am much more conscious of how and what the children are building, rather than simply that there are children in the block area. I look for and see elements such as: symmetry, bridging structures, stability, aesthetic versus functional details, planning and subsequent use of structures...my interest has continued to include the social issues involved in who builds (or doesn't) and how."

Since those early days of the project, teachers have continued to record visual notes based on their close observation of children. We have collected hundreds of sketches of children's work (see insert, Figure 1) and the analysis of our data has been ongoing. One major focus of our analysis has been the identification of the skills children are developing through their visual-spatial work. We realized quickly that the block area is an important arena for learning in particular because it allows children to develop and practice many different skills simultaneously. This article describes some of the skills visual-spatial work promotes.

When children work with blocks and related materials, they develop and practice CONSTRUCTION SKILLS. One of the products of our years of close observation of children's work in the block area is what we call a "construction typology" (see insert, Figure 2). The typology visually depicts construction skills from the most basic to more complex skills. The skills depicted on the typology were not copied from construction management textbooks, they were drawn directly from

teachers' visual notes – their sketches of what three, four, five, and six year old children were constructing in the block area. As children practice their construction skills, they learn about the function of objects and structures, such as: circulation systems (i.e., entrances, exits, pathways, how to navigate inside, outside, through and around) and volume (i.e., the spatial dimensions of the interior of the structure they create, and how many objects or children can fit inside that structure).

Children's visual-spatial work also conveys their KNOWLEDGE about structures and systems. We have seen many examples of children using this visual-spatial medium to communicate what they know about something...

- like the child who built a "pirate ship" with a crow's nest, flag mast, plank...even an "X" that marked the spot for buried treasure (though he couldn't necessarily name all those parts);
- or the group of children who spent 45 minutes constructing a large, rectangular structure they called a "swimming pool", complete with a drain for water, hoses for filling the pool, a hot tub, bubble makers and ramps to get into the pool. Thinking ahead, they constructed an area for "extra water" to use when it was time to refill the pool. Near the end of the construction, a child took several blocks and placed them inside the structure to symbolize water (Figure 3). And Piaget says preschool children don't have the ability to think abstractly yet!

Figure 3: Swimming Pool

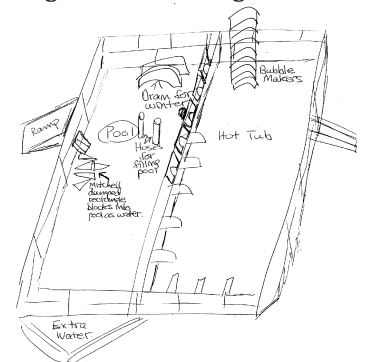

It is not uncommon for children's visual-spatial work to communicate their knowledge of something before they have the ability to verbalize it. Early in this project, "Danny" (a pseudonym), a verbally language-delayed child, silently built a castle. His castle had a dominant entrance with a drawbridge. It had towers and turrets, a dungeon, and a moat around it. Because his teacher was

closely observing his work, she recognized the significance of his communication and that Danny knew a lot about castles. He could not have verbalized the features of castles but his knowledge was clearly communicated through his visual-spatial work. This was a great “ah-ha” for us and the beginning of our understanding that visual-spatial is a language that must be recognized and supported. Had we relied only on traditional methods of knowledge-communication, we would have completely missed what this child knew!!!! One of the reasons visual notes are so powerful is that they give us insight into what children are thinking!

Children also convey EMOTIONS through their visual-spatial work. We have seen many examples of this. For example:

- a young girl built a square, flat structure, placed a car inside, and covered it with a roof. She called it a “garage” and explained to her teacher that the garage would keep the car safe from a bad person who might try to rob it;
- a child built a bridge and a road that led past a gas station and car wash, to an airport on the edge of “town” (sound familiar?). The child set a basket off to one side of the bridge and told his teacher that the basket would “trap bad guys” (Figure 4);

**Figure 4: Road to Airport**

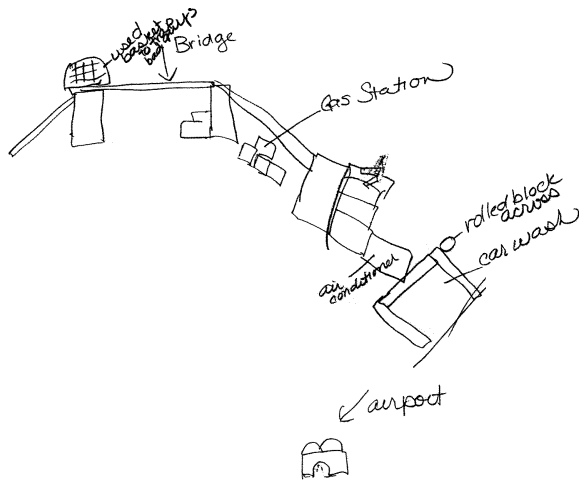

- a child became a tornado, twisting and twirling and swallowing up everything in its path, then became the person who saved everyone;
- shortly after 9/11 a child stacked blocks in the shape of a tower...held a single block in his hand, moved through the air and crashed the block into the tower, knocking it down. He rebuilt the tower and knocked it down with the single block, over and over again.

As we have witnessed the kinds of emotions children convey in their block work, we have hypothesized that this type of work provides children with a way to confront their fears. Children need to be able to do something to feel they have power – to be able to solve a problem or

resolve a frightening situation. Visual-spatial work may provide one avenue for them to become the physical master over their environment, which may in turn give them a greater sense of control, empowerment and self-confidence.

We believe that when children build cities out of blocks it allows them to practice ABSTRACT THINKING in a concrete medium. They need to decide which structures belong in a city (a classification skill), determine what the “whole” structure(s) might look like and what the “parts” of the structures consist of, then figure out how to physically build them. Their skill at this suggests that children are observing their environment closely, storing their experiences and visual images, recalling them and relying on their visual memory to re-create them in their block work. The way they lay out their cities and what they position where can illustrate their LOGICAL, SEQUENTIAL THINKING SKILLS.

Children are making VISUAL ANALOGIES (also called creative representation) when they intentionally select blocks to represent another item. We have seen many examples of this (Figure 5). We believe that making visual analogies with objects like blocks is a more sophisticated abstract thinking skill than picking up a pre-formed toy like a child’s telephone or doll furniture and using it for its intended purpose.

**Figure 5: Visual Analogies Children Have Made With Blocks**

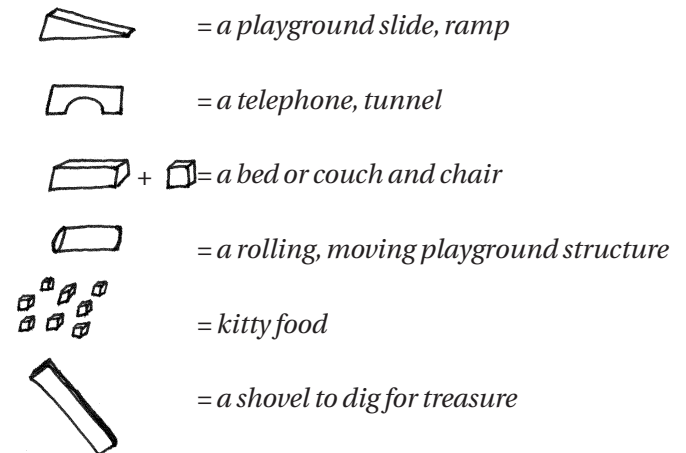

Besides developing construction skills, and conveying knowledge and emotions, children are learning many more skills through their visual-spatial work. Children develop basic SCIENCE PROCESS SKILLS as they work with visual-spatial materials. These skills include collecting information about objects through close observation; classifying objects into groups with common characteristics; exploring measurement concepts such as length, area, perimeter, and volume; predicting what will happen with an object as they manipulate it; experimenting with materials to see what happens, and drawing conclusions.

**Figure 6: 100% scale/Body-Size Structures**

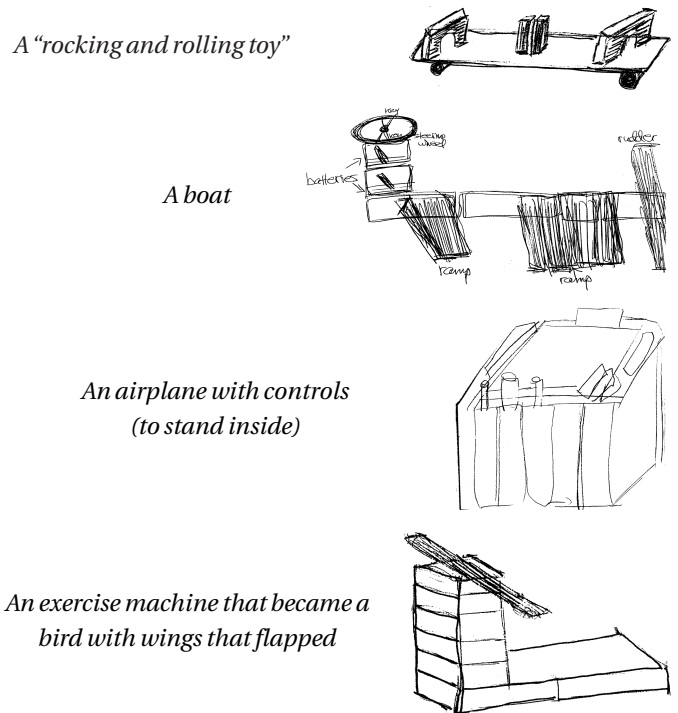

Through visual-spatial work, young children are also introduced to basic MATH concepts, such as base, height, width, length, and size. They develop early math skills including sorting objects by shape, color and size; counting; recognizing groups and patterns; sequencing; and recognizing numbers. Young children are even being introduced to fractions as they work with blocks. For example, a child wanted to build the outline of a house on the floor, but realized she did not have enough long blocks. On closer observation she noticed that one shorter block was half the size of the long block, and that two half-blocks equaled one long (whole) block!

With the introduction of non-standard blocks into the block area, children are introduced to basic GEOMETRIC SHAPES, such as cubes, cones, spheres, cylinders and pyramids. It is not uncommon for children to make the structures they create symmetrical, another geometric concept.

Through their experiments in the block area, children learn about scientific concepts such as FORCE and MOTION, or the absence of it. For example, children often experiment with ramps and cars and marbles. They discover if they adjust the height of the ramp, the force of acceleration is different. They learn about friction too, when they experiment with cars and marbles on different textured surfaces. They may not understand all of these mathematical or scientific concepts, but as they are re-introduced to them later, they will recall their physical experiences with the materials that cemented those concepts in their mind, which we believe will make learning easier!

Children are learning basic ARCHITECTURAL TERMS AND FEATURES through their work in the block area. For example, they have learned about the keystone in the arch, types of columns, dormers, catslides, and dentil moulding. Those concepts are reinforced as they make the shapes with their bodies and as they see these elements in the structures in their neighborhoods and homes.

Children who are highly KINESTHETIC (sometimes called BodySmart children) often have difficulty sitting still and prefer to learn about things by touching them. We have observed that kinesthetic children often build "life-size" structures that they can crawl or move through, be inside, stand or walk on, or somehow physically interact with. One of the concepts these children are learning about is SCALE-RELATIONSHIPS. We have seen children build houses and forts they could get inside, snowmobiles, batmobiles, airplanes, cars, and boats complete with steering wheels or controls, even time machines and exercise machines (Figure 6). For kinesthetic children, the physical manipulation of materials such as blocks, fabric, straws and connectors, pvc pipe, carpet squares, and tiles can be a powerful

learning tool. Physically handling materials builds muscle memory and helps cement concepts in children's minds.

As children share ideas, negotiate, make decisions, decide on tasks and roles, and problem-solve together in the block area, they are developing important SOCIAL AND ROLE PLAY SKILLS. They also develop VERBAL skills as they discuss their work with each other and their teacher. One young child examined a structure he built and commented to his teacher that the board on top was "stabilized" (imagine her surprise!). His work with blocks created an opportunity for him to use vocabulary that he would not typically use in conversation.

These are just some of the skills children are developing through their visual-spatial work, however, this list is not exhaustive. We are beginning our seventh year of research and continue to learn through close observation of children. Our data indicates that children are doing much more than "playing" in the block area. Key learning is taking place that will significantly impact children's future educational experiences and career choices. Our findings suggest that visual-spatial fluency is a language and may be the dominant mode of communication for some children. Just as we support reading, writing, and verbal literacy, it is equally important to support visual-spatial skill development for all children. We believe that especially for young children who are verbally language-delayed, the visual-spatial medium not only provides them with an avenue for communicating their knowledge, but may also provide a later link to verbal literacy (Figure 7).

Our research has great implications for the kinds of experiences and materials teachers and parents can provide to intentionally help children develop their

visual-spatial skills. A future newsletter article will offer ideas for activities and materials that can foster visual-spatial skill development.

**Figure 7: Visual notes: May 18, 1998**

*Teacher observes a 5 year old boy building an unnamed structure*

*Teacher's sketch:*

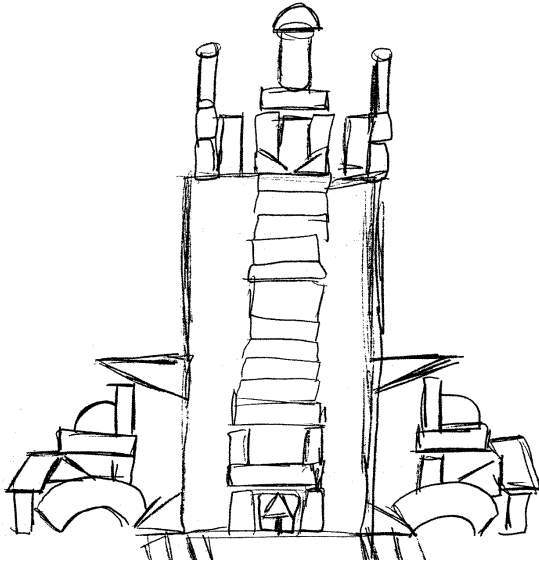

*Child's sketch:*

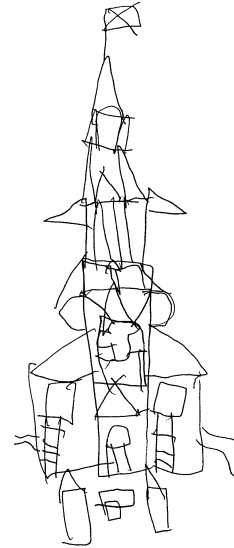

Note: As the teacher sketched this child's structure he said: "I'll draw it for you". It took the teacher 10-15 minutes to sketch, while he drew it "easily and confidently" in less than five. This child had strong visual-spatial skills and was considered to be one of the "master builders" but at the time was identified as verbally language-delayed. He would have had difficulty describing his structure to his teacher verbally, but he easily represented it visually. When he completed his sketch, he printed his name below it (removed to protect his anonymity). He had difficulty writing, and this was the first time he had written his name on anything at school. This incident in particular encouraged us to think about the link between visual-spatial work and written and verbal literacy.

## Did you know?

- Children with high visual-spatial intelligence think in pictures and images...are imaginative and creative...are visual learners. They are keen observers of the world around them, noticing subtleties and details that most of us miss. They also tend to have an excellent awareness of space and the orientation of their bodies to others.
- Spatially smart children are good with puzzles, blocks and other construction toys because: "you have to be able to visualize where a piece might go by turning it around in your mind". These children can also translate concepts from a two-dimensional piece of paper to the three-dimensional world (Ellen Winner, Harvard Project Zero).
- Research indicates that if students are able to visualize, they have a much greater chance for success in math (Jan Melancon, Loyola University).
- The ability to rotate and manipulate figures seems to be the skill most directly related to success in geometry.
- Spatial abilities improve as children become more involved with tasks such as model building, working with 3-D objects such as blocks and replica buildings, and solving spatial visualization problems.
- Many children with learning disabilities appear to have significant strengths in visual-spatial intelligence.
- In most cases, the visual-spatial learning style is not addressed in school, so these learners' self-esteem may suffer. Because children who are gifted spatially are often not as strong in verbal skills they may end up feeling like failures if their strengths are not supported (Linda Silverman & Ellen Winner).
- Adults with strong visual-spatial skills generally make good architects, mechanical engineers, surveyors, visual designers, photographers, surgeons, pilots, artists, and computer programmers (to name a few occupations!).

**Figure 2: Sample Categories – Construction Typology**

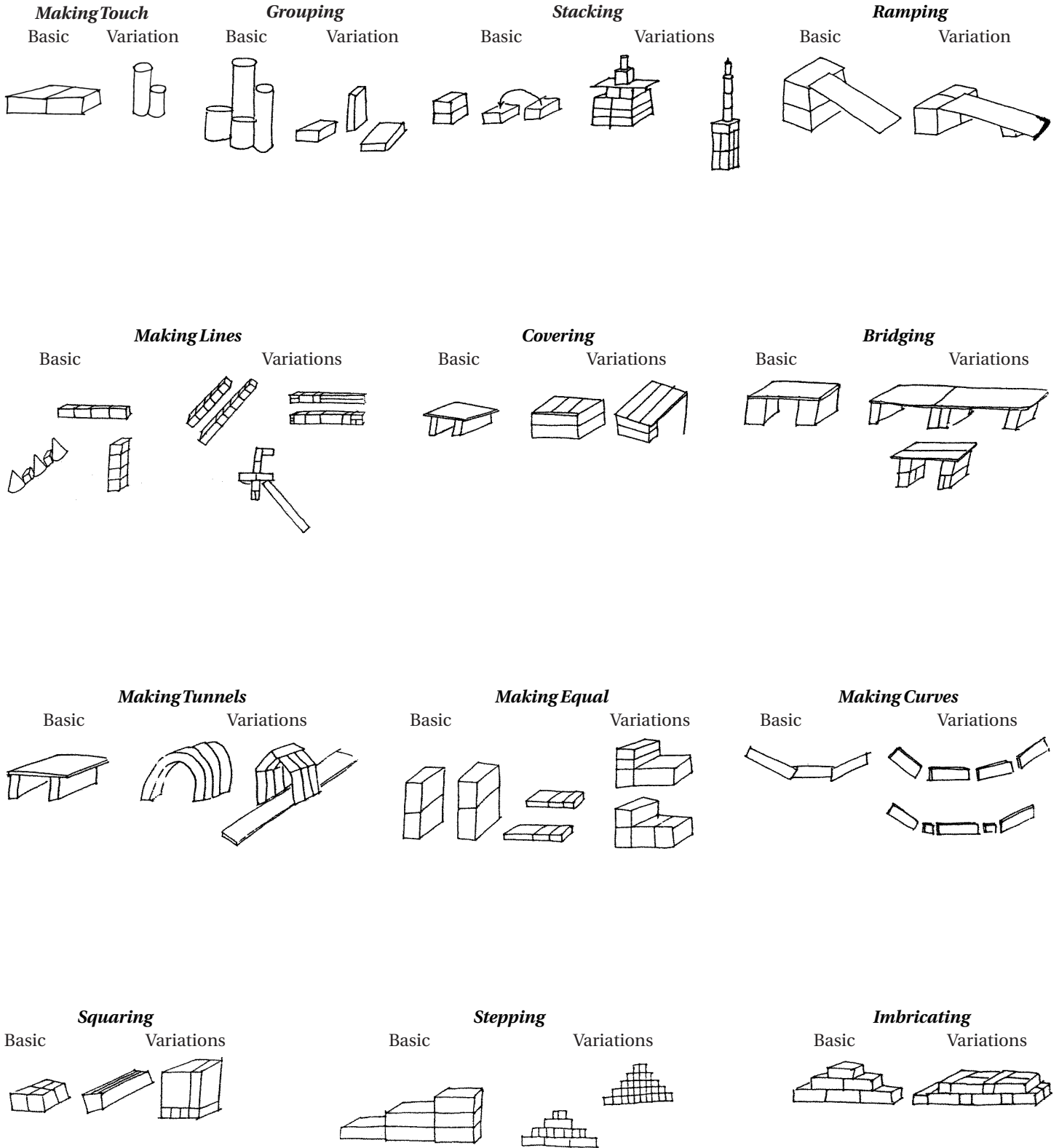

**Figure 1: Samples of Teachers' Visual Notes**

**House Enclosure**

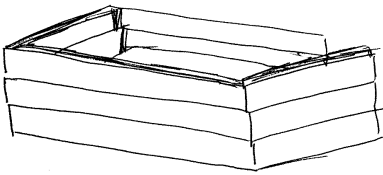

**Castle Racetrack**



Cars zoom down ramp into castle

did repeated tests of the track, modifying the design slightly each time.

**Motel**

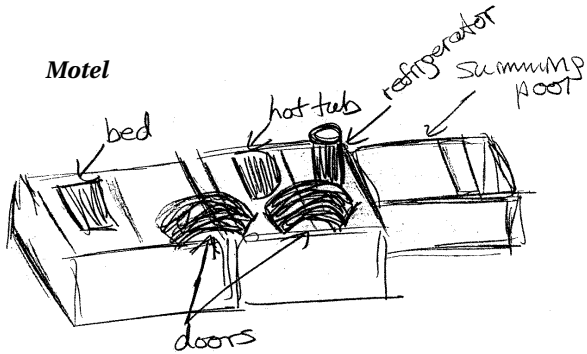

bed

hot tubs

refrigerator

sunbump foot

doors

**Dinosaur Museum**

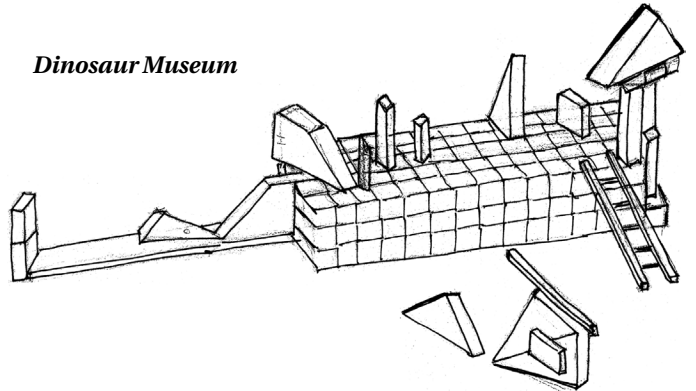

**Playground**

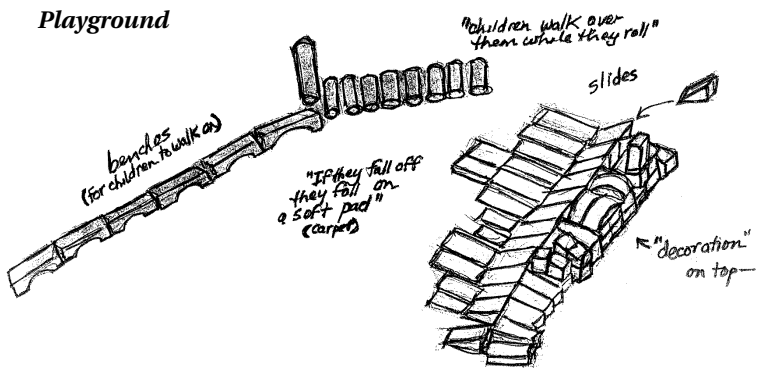

benches (for children to walk on)

"children walk over them while they roll"

slides

"if they fall off they fall on a soft pad" (carpet)

"decoration" on top

**Ramp**

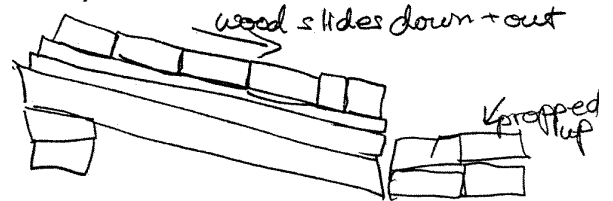

wood slides down + out

propped up

**Enclosure using non-standard blocks**

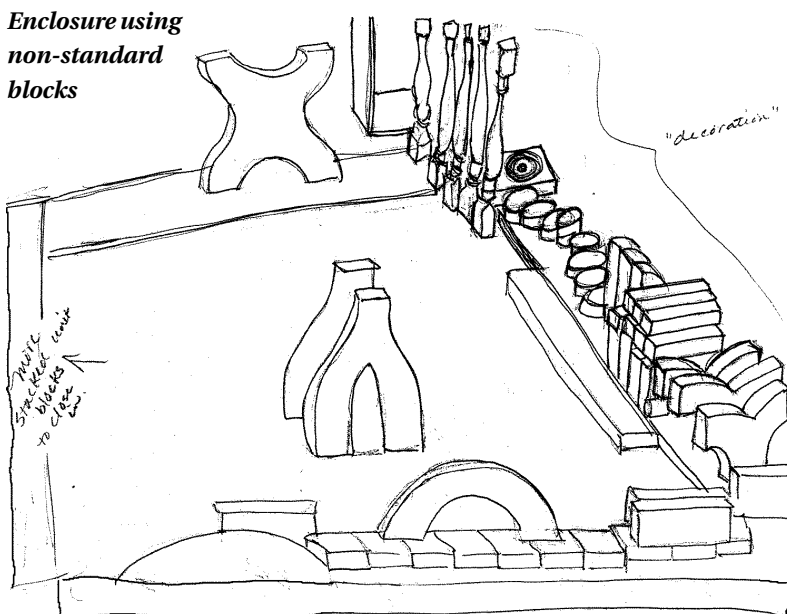

"decoration"

Make structure count to close

**Castle**

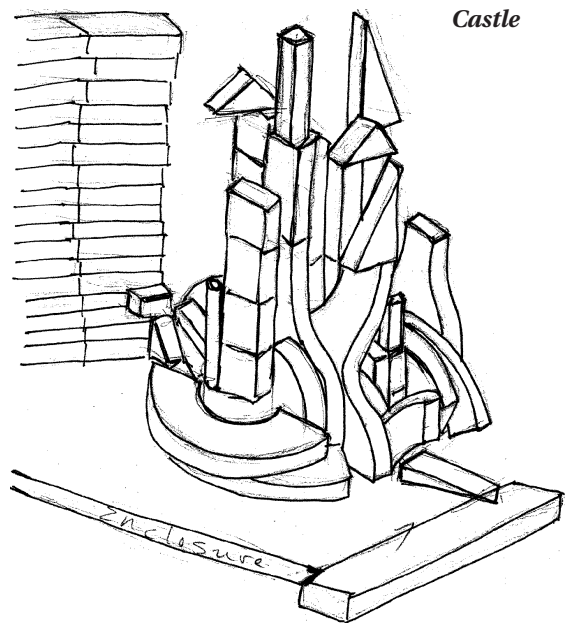

enclosure

Over